

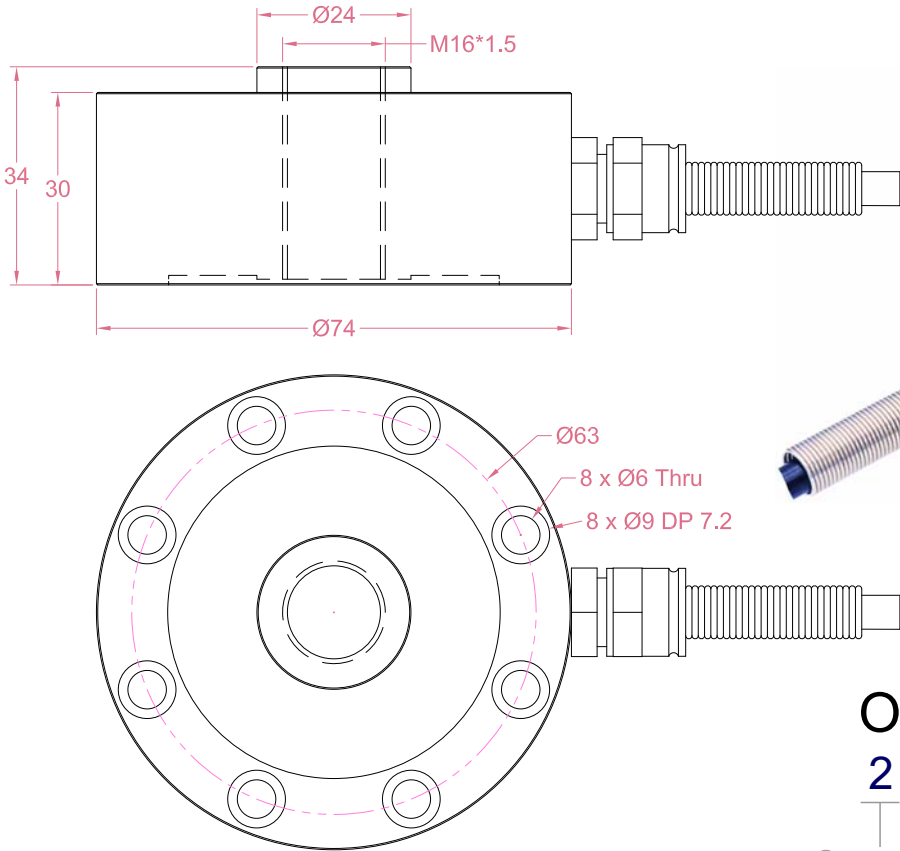

Dimensions in "mm"

96usd/pc



Order example:

2 x LCP03 - 500kg

Quantity Model Capacity

Email to sales@loadcellsensor.com for a quote

Specifications			
Rated Capacity	50/100/200/300/500/1000 kg		
Rated Output	2.0 mV/V	Compensated Temp.	0...+40°C
Excitation	3~15V	Operating Temp.	-20...+60°C
Zero Balance	±0.05 mV/V	Temp. Coeff. of Zero	±0.005% F.S./°C
Nonlinearity	±0.1% F.S.	Temp. Coeff. of Span	±0.005% F.S./°C
Hysteresis	±0.1% F.S.	Input Resistance	750±100 Ohms
Nonrepeatability	±0.05% F.S.	Output Resistance	700±100 Ohms
Creep(5min)	±0.05% F.S.	Insulation Resistance	>2000M Ohms(50V)
Safe Load Limit	150% F.S.	IP Rating	IP65
Breaking Load	200% F.S.	Element Material	Alloy steel
Cable	Ø5.5*2000mm 4-conductor shielded cable		

• LCS reserves the right to modify its design and specifications without notice





Load direction

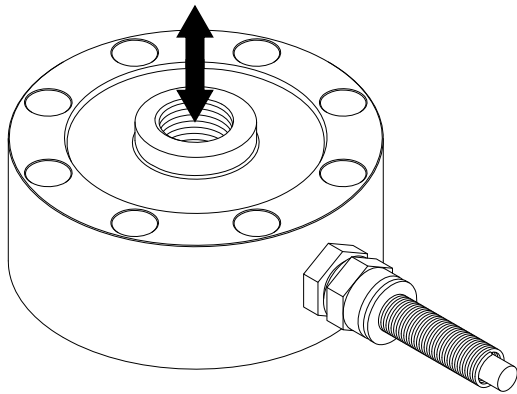

Wiring Code@Compression

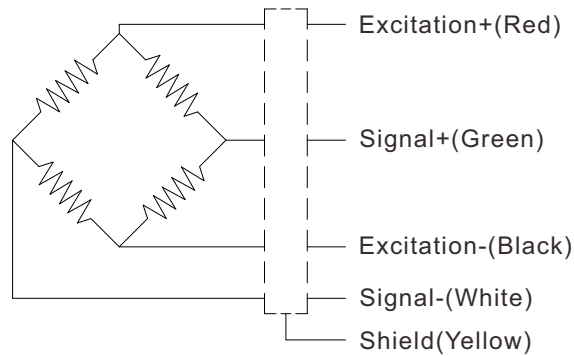

Shield is NOT connected to the sensor body

Load button

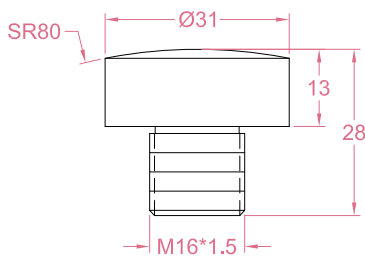

Material: Alloy steel
 Item No.: LCP03-LB

Load flange

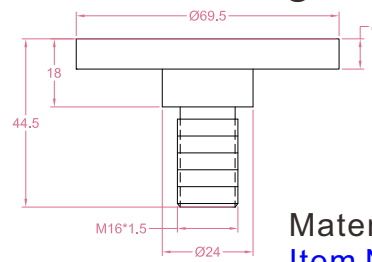

Material: Alloy steel
 Item No.: LCP03-LF

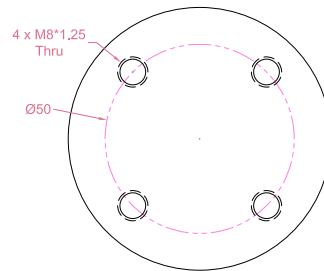

Sensor/Amplifier/Indicator

Items	Power supply	Output/Function
LCP03	3-15V (Constant)	-30mV...+30mV (Depending on the power supply)
LCP03 + Analog amplifier	12~24V DC	0-3.3V,0-5V,0-10V, -5-5V,-10-10V,0-5-10V 0-20mA,4-20mA,4-12-20mA...
LCP03 + Digital amplifier	12~24V DC	RS485 or RS232 output
LCP03 + Indicator	12~24V DC	Display force value Switch/Relay output Peak holding RS485/RS232 interface 0-5V/0-10V/4-20mA output

Email us for datasheet of amplifier and indicator

